







ST 060 113 2985



- cover plate 120 x 120 mm
- rosette 60 x 60 mm
- temperature control handle with safety limit stop at 38°C
- thermostat cartridge
- 2x head part with cut-to-length spindle and sleeve

| | | |
|--|-----------------------------------|--------------------|
|  | Brushed Platinum | ST 060 113 2985-06 |
|  | Chrome | ST 060 113 2985-00 |
|  | Platinum | ST 060 113 2985-08 |
|  | Brushed Light Gold | ST 060 113 2985-27 |
|  | Brushed Durabronze (23kt Gold) | ST 060 113 2985-28 |
|  | Brushed Chrome | ST 060 113 2985-93 |
|  | Brushed Dark Platinum | ST 060 113 2985-99 |

Individual components of this set

You need the following components for this set

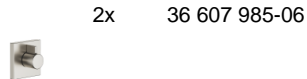
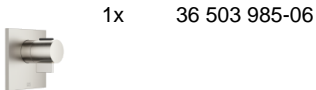



SYMETRICS xTOOL Thermostat module - Brushed Platinum

IMO

ST 060 113 2985

ST 060 113 2985



- cover plate 120 x 120 mm
- temperature control handle with safety limit stop at 38°C
- thermostat cartridge

Fits: IMO, MEM, CL.1, CYO

| | | |
|--|-------------------------------|---------------|
|  | Brushed Platinum | 36 503 985-06 |
|  | Chrome | 36 503 985-00 |
|  | Platinum | 36 503 985-08 |
|  | Dark Chrome | 36 503 985-19 |
|  | Brushed Light Gold | 36 503 985-27 |
|  | Brushed Durabronz (23kt Gold) | 36 503 985-28 |
|  | Matte Black | 36 503 985-33 |
|  | Brushed Champagne (22kt Gold) | 36 503 985-46 |
|  | Champagne (22kt Gold) | 36 503 985-47 |
|  | Brushed Chrome | 36 503 985-93 |
|  | Brushed Dark Platinum | 36 503 985-99 |

Required miscellaneous



- xTOOL Concealed thermostat module without volume control -** 35 503 970 90
- max. recess depth 160 mm
 - min. recess depth 95 mm

ST 060 113 2985

mm [inches]

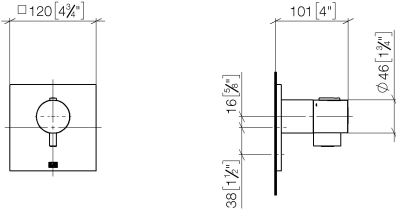

Flow rate chart

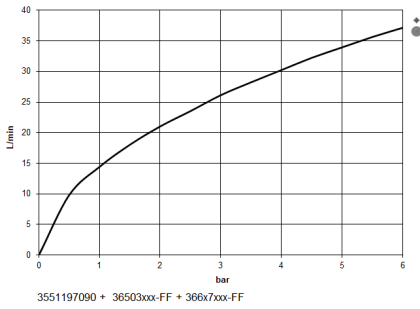

Certificates

WRAS_2011026.

DVGW_DW-
6512DN0706.

LGA_29930.

LGA_29932.

ST 060 113 2985

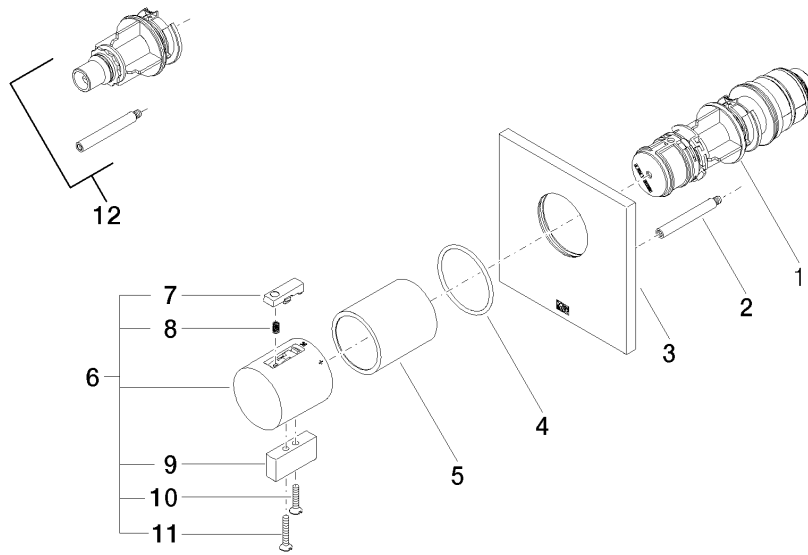







Spare parts list

| No. | Item Number | Name | Quantity used | Delivery time |
|-----|--------------------|-------------------|---------------|---------------|
| 1 | 90 15 02 063 00 90 | cartridge | 1 | 2 |
| 2 | 90 31 09 095 00 90 | bar | 1 | 2 |
| 3 | 09 11 02 196-06 | cover | 1 | 60 |
| 4 | 90 14 10 049 00 90 | seal | 1 | 2 |
| 5 | 90 21 02 112 00-06 | sleeve | 1 | 10 |
| 6 | 04 17 33 006 00-06 | handle | 1 | 60 |
| 7 | 90 21 33 011 00-13 | handle | 1 | 2 |
| 8 | 90 16 02 027 00 90 | spring | 1 | 2 |
| 9 | 09 20 33 006-06 | handle | 1 | 10 |
| 10 | 09 30 30 159-06 | screw | 1 | 10 |
| 11 | 09 30 30 160-06 | screw | 1 | 10 |
| 12 | 12 178 970 90 | Extension 46 mm - | 1 | 2 |

ST 060 113 2985

- rosette 60 x 60 mm
- head part with cut-to-length spindle and sleeve



| | | |
|--|-----------------------------------|---------------|
|  | Brushed Platinum | 36 607 985-06 |
|  | Chrome | 36 607 985-00 |
|  | Platinum | 36 607 985-08 |
|  | Brushed Light Gold | 36 607 985-27 |
|  | Brushed Durabronze (23kt Gold) | 36 607 985-28 |
|  | Brushed Chrome | 36 607 985-93 |
|  | Brushed Dark Platinum | 36 607 985-99 |

Required miscellaneous



- Wall valve 1/2" -** 35 607 970 90
- max. recess depth 145 mm
 - min. recess depth 75 mm



SYMETRICS xTOOL Thermostat module - Brushed Platinum

IMO

ST 060 113 2985

ST 060 113 2985

mm [inches]

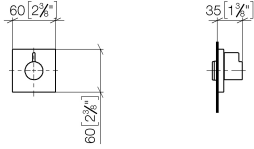

Certificates

DVGW_DW-
6501DN0116.

WRAS_2011026.

IAPMO_4976 (1).

LGA_29931.

WRAS_2010066.

DVGW_DW-
6512DN0706.

LGA_29932.

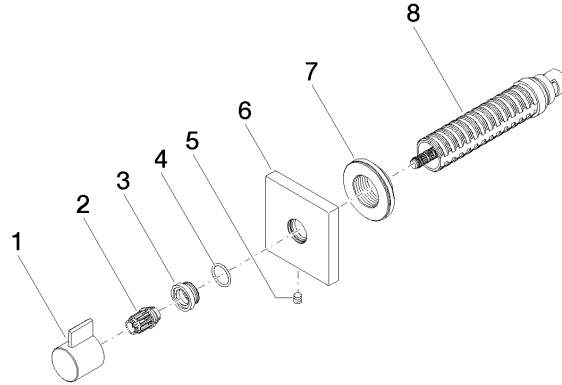

Spare parts list

| No. | Item Number | Name | Quantity used | Delivery time |
|-----|--------------------|------------|---------------|---------------|
| 1 | 09 20 98 002-06 | handle | 1 | 10 |
| 2 | 09 12 12 005 90 | fixing cap | 1 | 2 |
| 3 | 09 12 12 043-06 | base | 1 | 10 |
| 4 | 09 14 10 017 90 | seal | 1 | 2 |
| 5 | 90 31 11 004 00 90 | pin | 1 | 2 |
| 6 | 09 27 98 014-06 | rosette | 1 | 10 |
| 7 | 09 21 02 151 90 | sleeve | 1 | 2 |
| 8 | 90 90 03 202 00 90 | top | 1 | 2 |